

Data Sheet



Article number: 2307080653
 Description: E+G Small counter
 DD50-AR-01.0-D-AR Orange

Measures

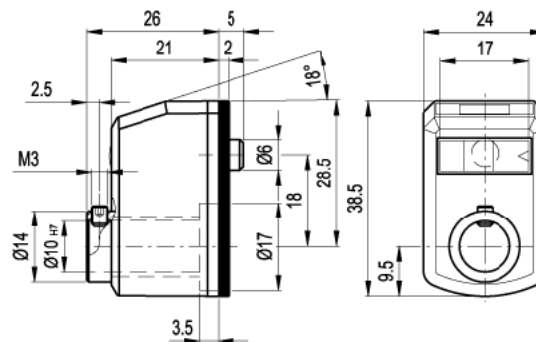

Table of the possible combinations							
Reading position	Pitch	Reading after one revolution			Speed (rpm)*	Direction of rotation	Colour
		0	1	0			
AN Analog upper	1.0	01.0	0.10	010	1500	D clockwise	AR orange RAL 2004
AR Analog lower	2.0	02.0	0.20	020	1250		
FN Front upper	4.0	04.0	0.40	040	625	S anti-clockwise	GR grey RAL 7035
FR Front lower	5.0	05.0	0.50	050	500		
	10	10.0	1.00	100	250		

01.0	Standard reading
0.10	Reading available on request (see 17.4.2012)

DD50 - FR - 010 - S - GR

* The maximum rotation speed (rpm) of the spindle reported in the table corresponds to a maximum rotation speed of 25,000 units per minute of the test roll on the right side of the counter. Rotational speed tests have been performed in our laboratory under standard operating conditions.

Description = Se mål på tegning